

LUMBER PATTERN DATA SHEET

LOG CABIN LUMBER PATTERNS | V1.0



LUMBER PROFILE **LOG CABIN SIDING (1" x 8")**

FIND THIS PATTERN IN OUR LUMBER PATTERN BOOK ON PAGE 18

>> NOTE: Dimensioned pattern drawings are drawn to scale and presented at 100% unless otherwise indicated.

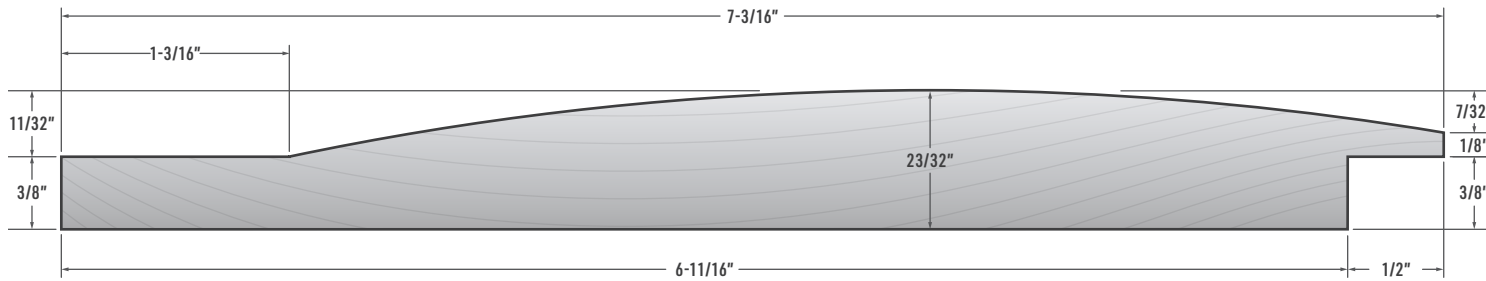

SCAN HERE

Get a digital copy of our *Lumber Pattern Book* by scanning the QR Code or by visiting our website at: westernwoodsinc.com

PROFILE VIEW



INSTALLED VIEW

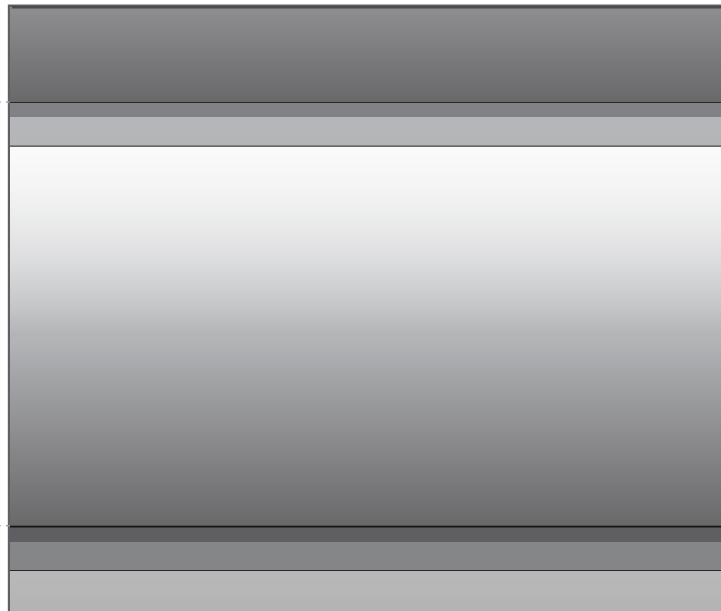

SIZE OPTIONS

NOMINAL SIZE	PATTERN NO.	A	B	CONVERSION FACTOR
-- SEE DOCUMENTED SIZE DATA ABOVE --				
-	-	-	-	-
-	-	-	-	-
-	-	-	-	-

DISCLAIMER: The dimensions of the delivered product is subject to change due moisture variations experienced by the product during the drying process, storage, or transportation. Site environmental conditions also apply. See page 36 for additional information. Milling variations apply. Consult your local building code for tolerances and specifics.

LUMBER PATTERN DATA SHEET

LOG CABIN LUMBER PATTERNS | V1.0

ALIGNMENTS

- ✓ Horizontal
- ✓ Vertical

NOMINAL SIZES

1 1/2" x 6"

1 1/2" x 8"

1 1/2" x 10"

1 1/2" x 12"

NAIL TYPES

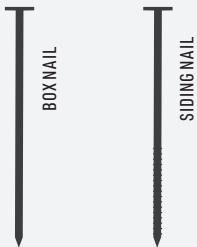

B **BOX NAIL** - Wide head flat, smooth shaft.

S **SIDING NAIL** - Wide flat head, ribbed shaft.

! WARNING: Do not nail through any of the over-lapping pieces.



DESCRIPTION

Log Cabin Patterns are 1 1/2" thick at the thickest point. These patterns are ideally suited to informal building in a rustic settings. Log Cabin may be milled from appearance grades ('Commons') or dimension grades [2x material]. Allow for a 1/2" overlap [rabbet, C], including an approximate 1/8" gap [B].

NAILING PATTERNS

FIND THIS PATTERN IN OUR LUMBER PATTERN BOOK STARTING ON PAGE 18

LEGEND

- 1** NAILS MUST PENETRATE 1 1/2" INTO SOLID WOOD.
- 2** USE TWO SIDING OR BOX NAILS PER BEARING 3 - 4" APART.
- A** USE ONE SIDING OR BOX NAILS PER BEARING.
- B** 1/8" = GAP FOR EXPANSION
- C** 1/2" = LENGTH OF RABBET (OVERLAP).
- 1** POSITION LOWER NAIL 1 1/2" FROM THE BOTTOM.
- A** HOUSE WRAP
- B** SHEATHING
- C** STUD
-  SIDING
-  NAIL DEPTH
-  NAIL

PROFILE VIEW

A profile view of the pattern before installation.



NAILING PATTERNS 6" AND NARROWER

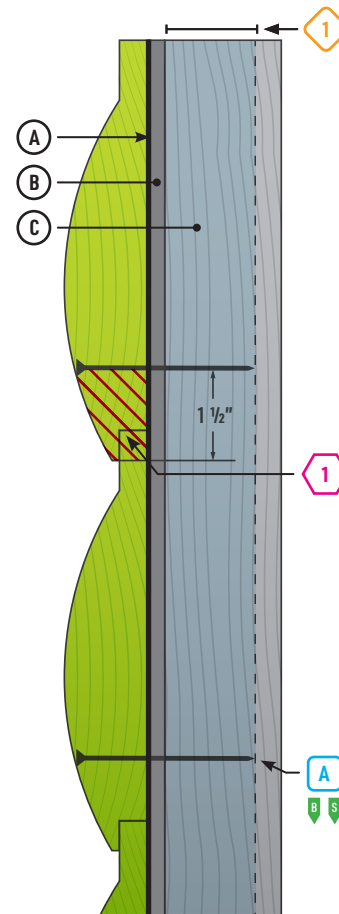

NAILING PATTERNS 8" AND WIDER

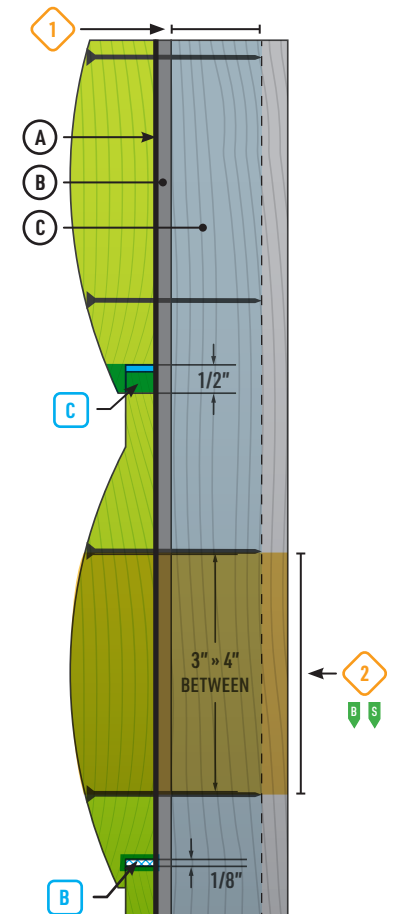

CONTENT SOURCE INSTALLATION RECOMMENDATIONS & NAILING PATTERNS PROVIDED BY WWPA.